

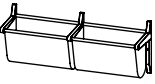









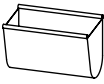

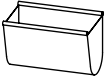

norrgavel

	 x3	 x2	 x8	 x4	 x2
+ 	 x2	 x1	 x4	 x2	 x2

1.

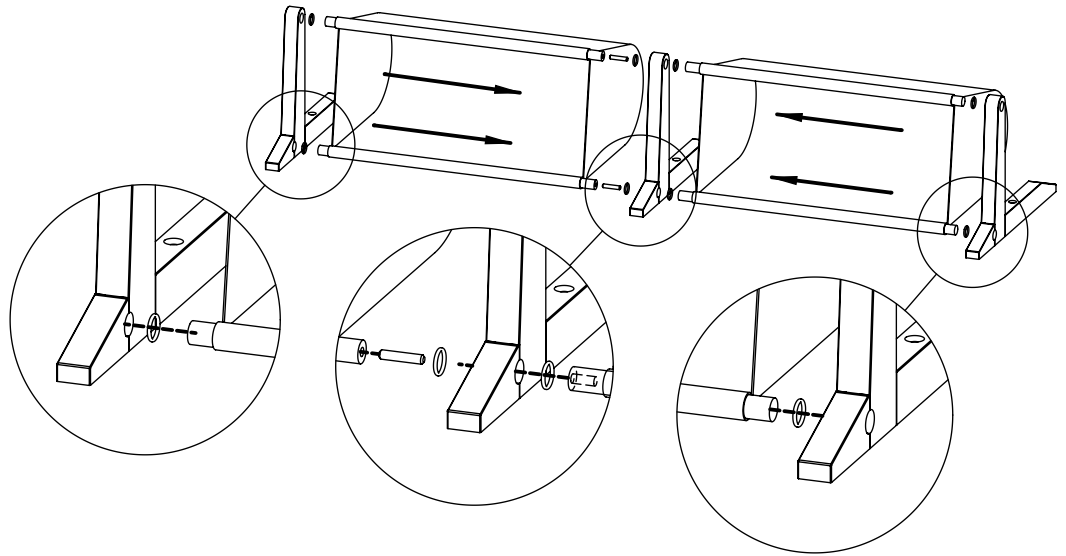

2 (+ ).

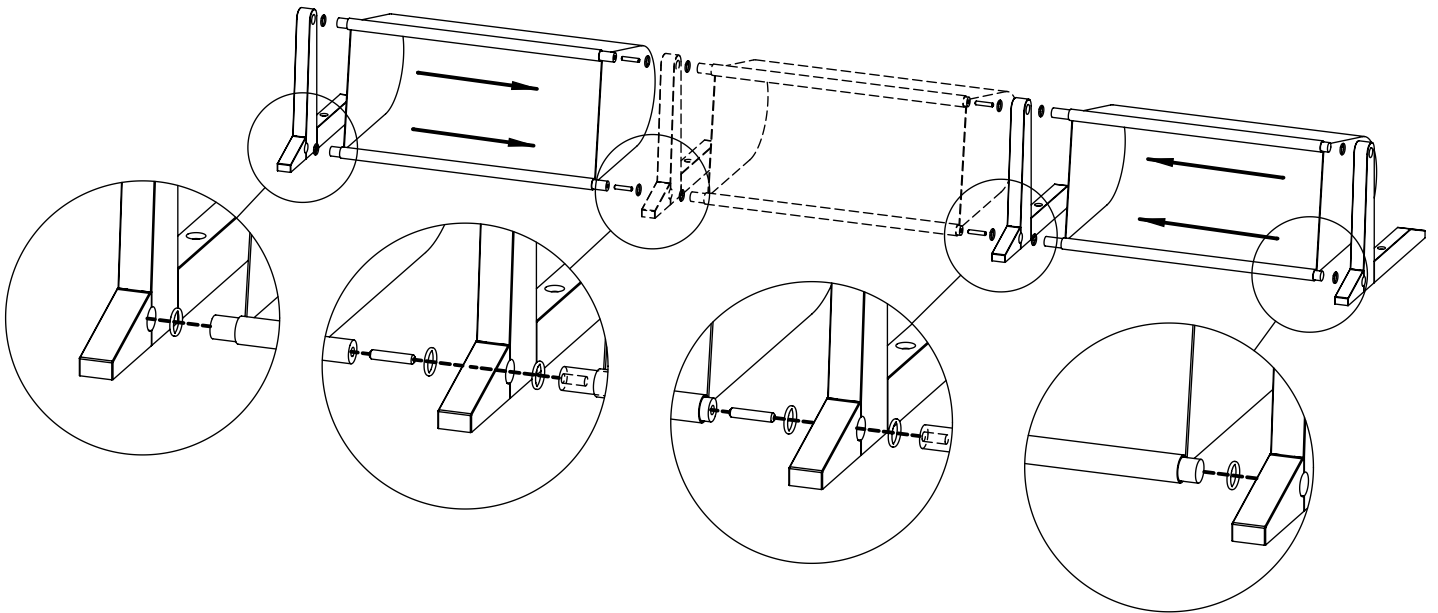

3.

